

Réf. 3690 - Galion

 *Jeu adapté aux handicaps moteurs*





Réf. **3690 - Galion**

Vue en élévation et plan de masse

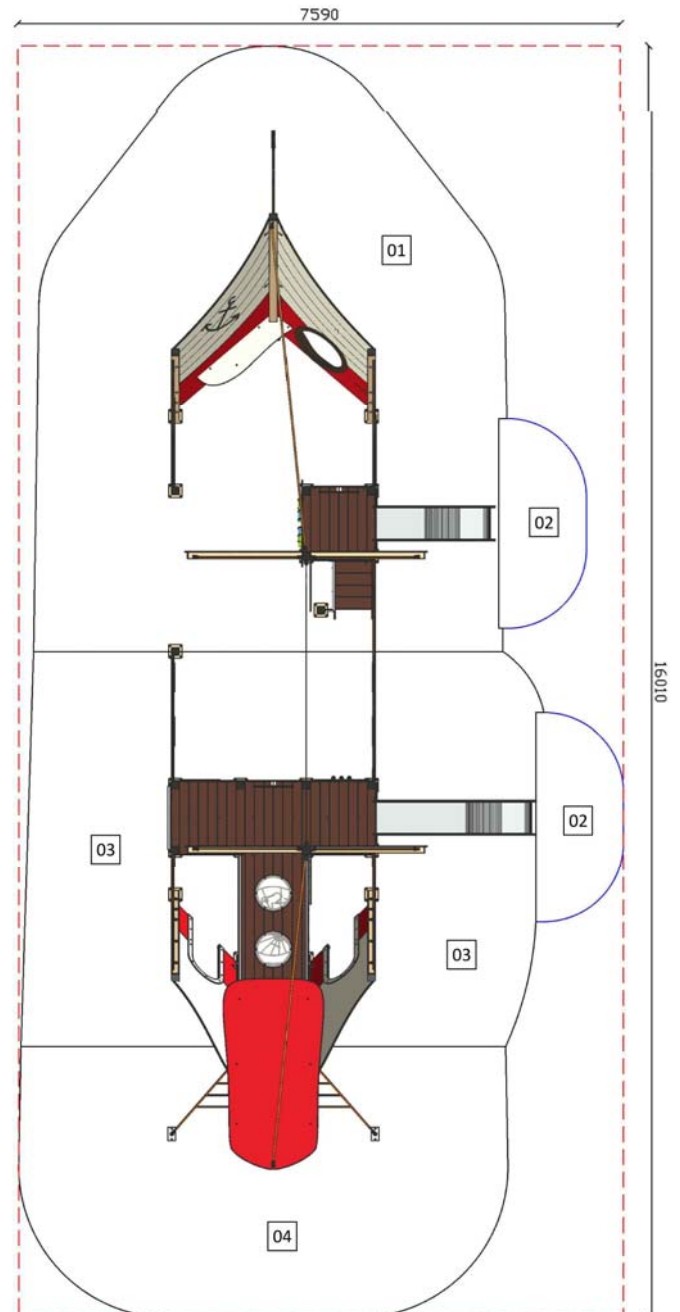
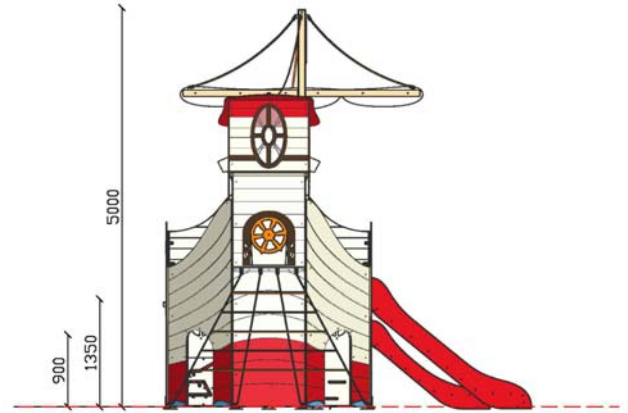

Surface HCL : 94.40 m²

01: HCL 0.90 m = 38.50 m²

02: HCL 1.00 m = 05.00 m²

03: HCL 1.35 m = 31.50 m²

04: HCL 1.80 m = 19.40 m²



Réf. 3690 - Galion

Fonctions ludiques du jeu

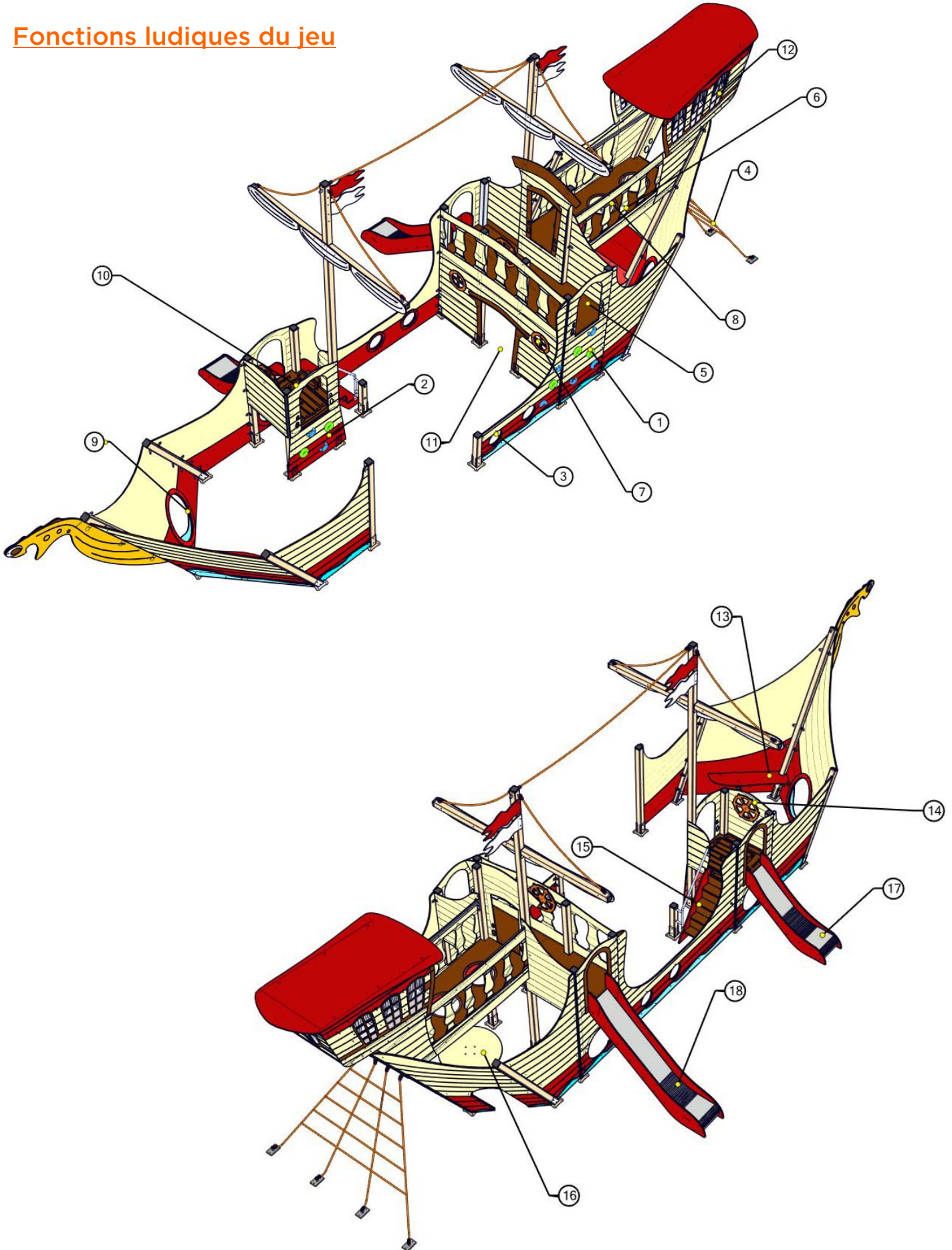

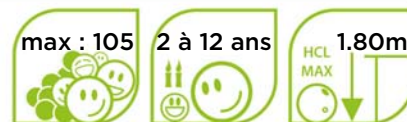

Réf. 3690 - Galion

Fonctions ludiques du jeu (suite)

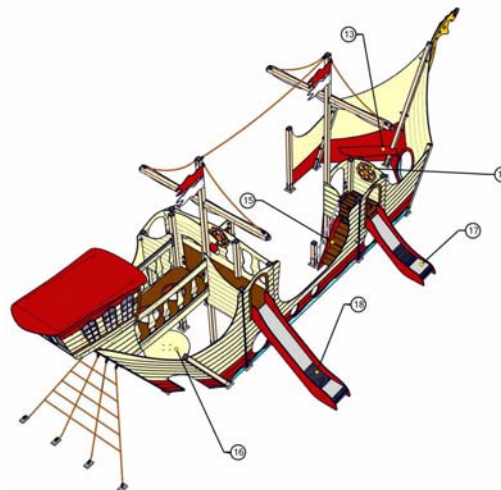
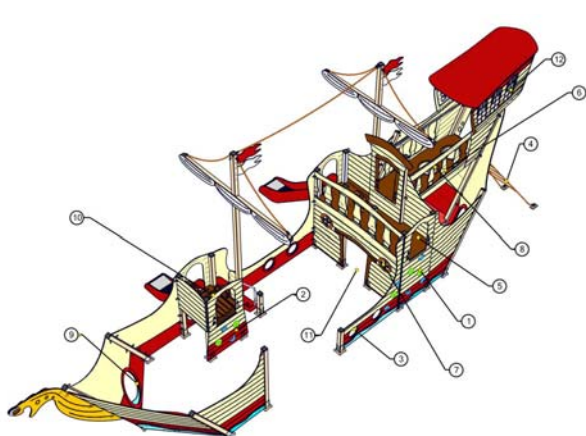

Fonctions ludiques	Désignations	Réf.	N°	Matériaux	Quantité
Imaginer	Galion	3690	-	HPL + alu + inox + cordes	1
Escalader	Mur d'escalade 1.35m	3690	1	HPL + polyuréthane	1
Escalader	Mur d'escalade 0.90m	3690-A	2	HPL + polyuréthane	1
Observer	Hublots bas	3690	3	HPL	4
Grimper	Cordes	3690-F	4	Cordes	1
Traverser	Passerelle plate 1.35m	3690-GP	6	HPL	1
Traverser	Passerelle plate 1.70m	3690-P	6	HPL	1
Observer	Hublots hauts	3690-34	7	HPL	2
Observer	Hublots polycarbonates	3690-P-03	8	Polycarbonate	3
Traverser	Trou de souris	3690-04	9	HPL	3
Fabuler, se rencontrer	Plancher	3000-F	10	HPL	1
Circuler	Porte	3693	11	HPL	3
Regarder	Fenêtre	3690-40	12	Polycarbonate	6
S'asseoir	Banquette	3690	13	HPL	2
Manipuler	Volant de bateau	3690-20	14	HPL	2
Monter, descendre	Escalier	3690-B	15	HPL + inox	1
Manipuler	Table ludique	3690-T	16	HPL	1
Glisser	Toboggan 0.90 m	96940	17	HPL + inox	1
Glisser	Toboggan 1.35 m	96950	17	HPL + inox	1

Total des fonctions ludiques : 36

Accessibilités Andy'



La chaise roulante a accès directement sur le jeu ou la structure. Présence d'une aide au transfert et aux déplacements / accès large / tables accessibles.



Réf. 3690 - Galion

Plan de la zone HCL

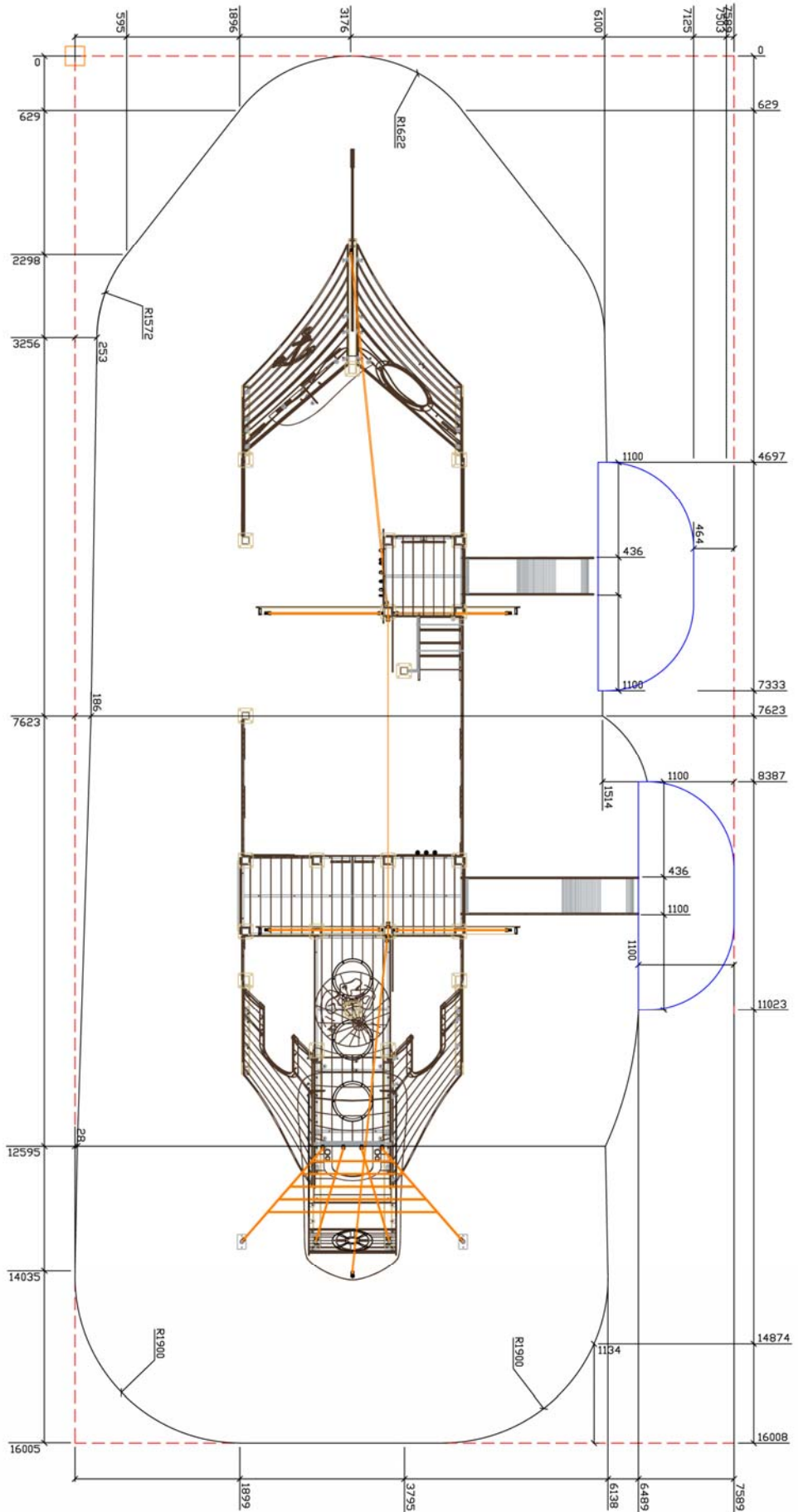



Réf. **3690 - Galion**

Éclatées et pièces détachées

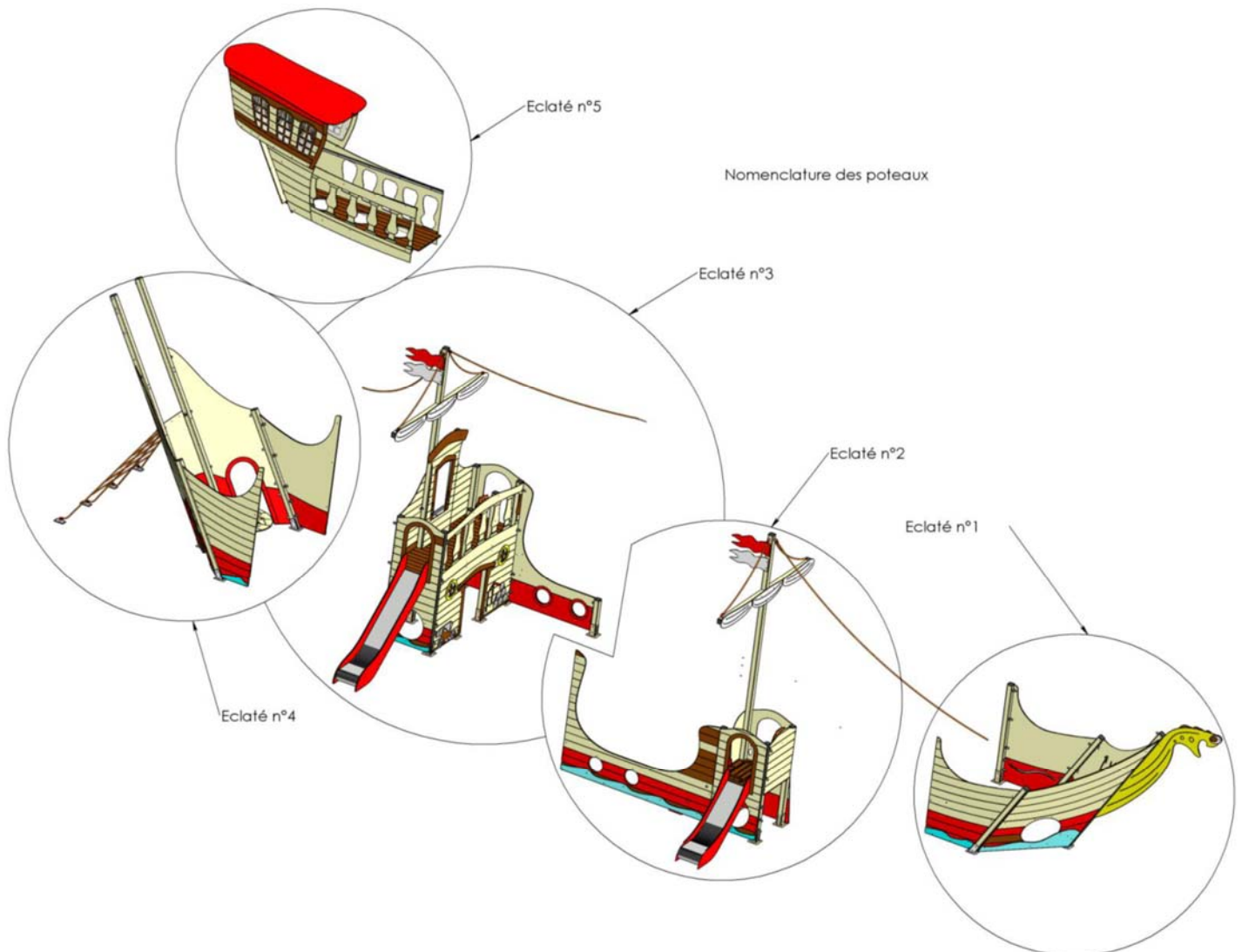

Nomenclature, pièces détachées

Vous pouvez commander vos pièces détachées
par téléphone au : **(+33) 04 76 64 75 18** –
par fax au : **(+33) 04 76 64 79 79** –
par mail à : info@transalp.fr



Réf. 3690 - Galion

Ensemble des poteaux

N° REFERENCE DESCRIPTION

1	3690-AL-P1	Aluminium	13	3690-AL-P13	Aluminium
2	3690-AL-P2	Aluminium	14	3690-AL-P14	Aluminium
3	3690-AL-P3	Aluminium	15	3690-AL-P15	Aluminium
4	3690-AL-P4	Aluminium	16	3690-AL-P16	Aluminium
5	3690-AL-P5	Aluminium	17	3690-AL-P17	Aluminium
6	3690-AL-P6	Aluminium	18	3690-AL-P18	Aluminium
7	3690-AL-P7	Aluminium	19	3690-AL-P19	Aluminium
8	3690-AL-P8	Aluminium	20	3690-AL-P20	Aluminium
9	3690-AL-P9	Aluminium	21	3690-AL-P21	Aluminium
10	3690-AL-P10	Aluminium	21	3690-AL-P22	Aluminium
11	3690-AL-P11	Aluminium	23	3690-V	Aluminium
12	3690-AL-P12	Aluminium			

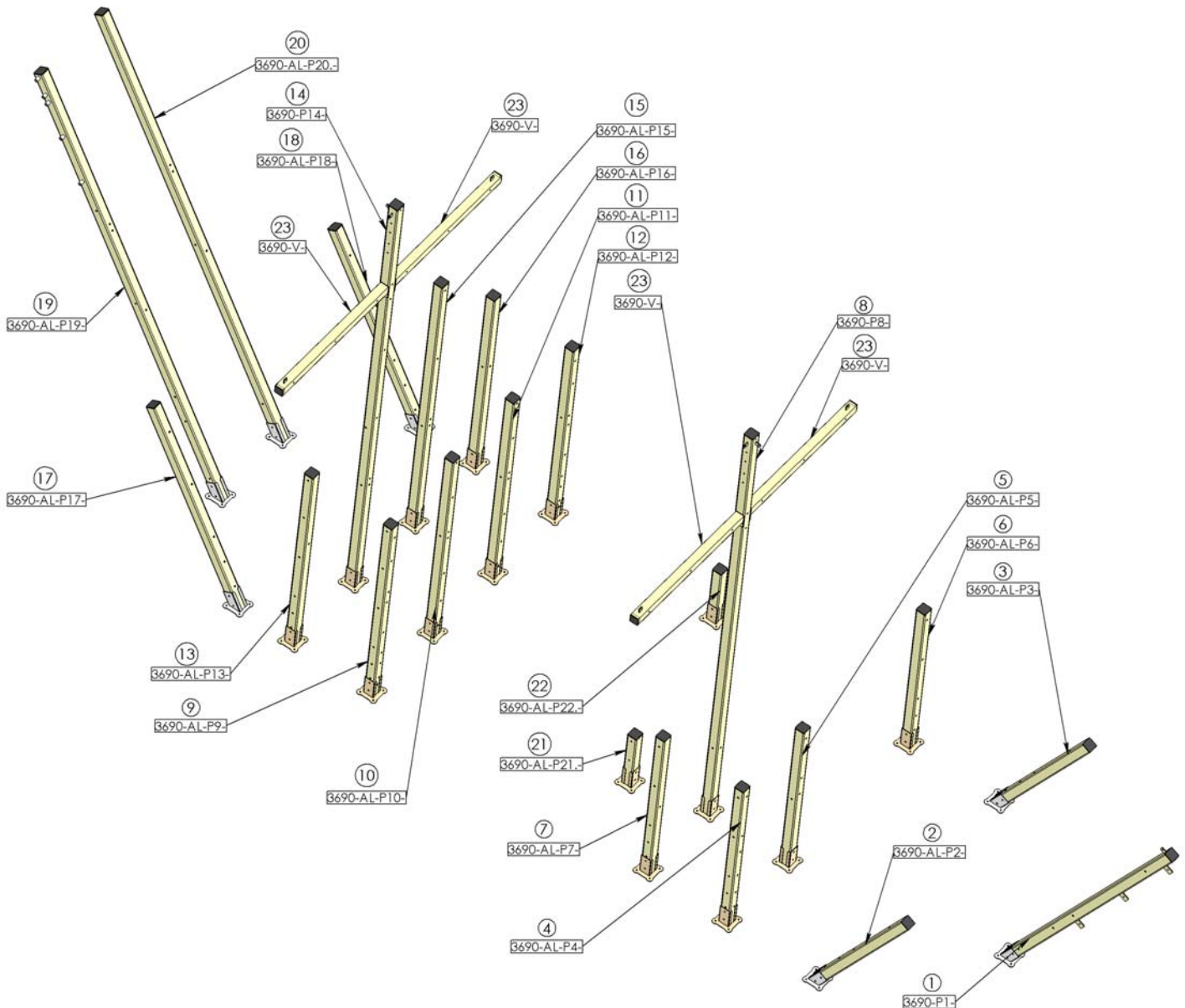



Réf. 3690 - Galion

Éclatée n°1

N° REFERENCE DESCRIPTION

1	720-08	HPL	12	3690-11	HPL
2	3690-01	HPL	13	3690-13	HPL
3	3690-02	HPL	14	3690-14	HPL
4	3690-03	HPL	15	3690-72	HPL
5	3690-04	HPL	16	3690-73	HPL
6	3690-05	HPL	17	3690-75	HPL
7	3690-06	HPL	18	3690-76	HPL
8	3690-07	HPL	19	3690-80	HPL
9	3690-08	HPL	20	3690-81	HPL
10	3690-09	HPL	21	12221-02	HPL
11	3690-10	HPL			

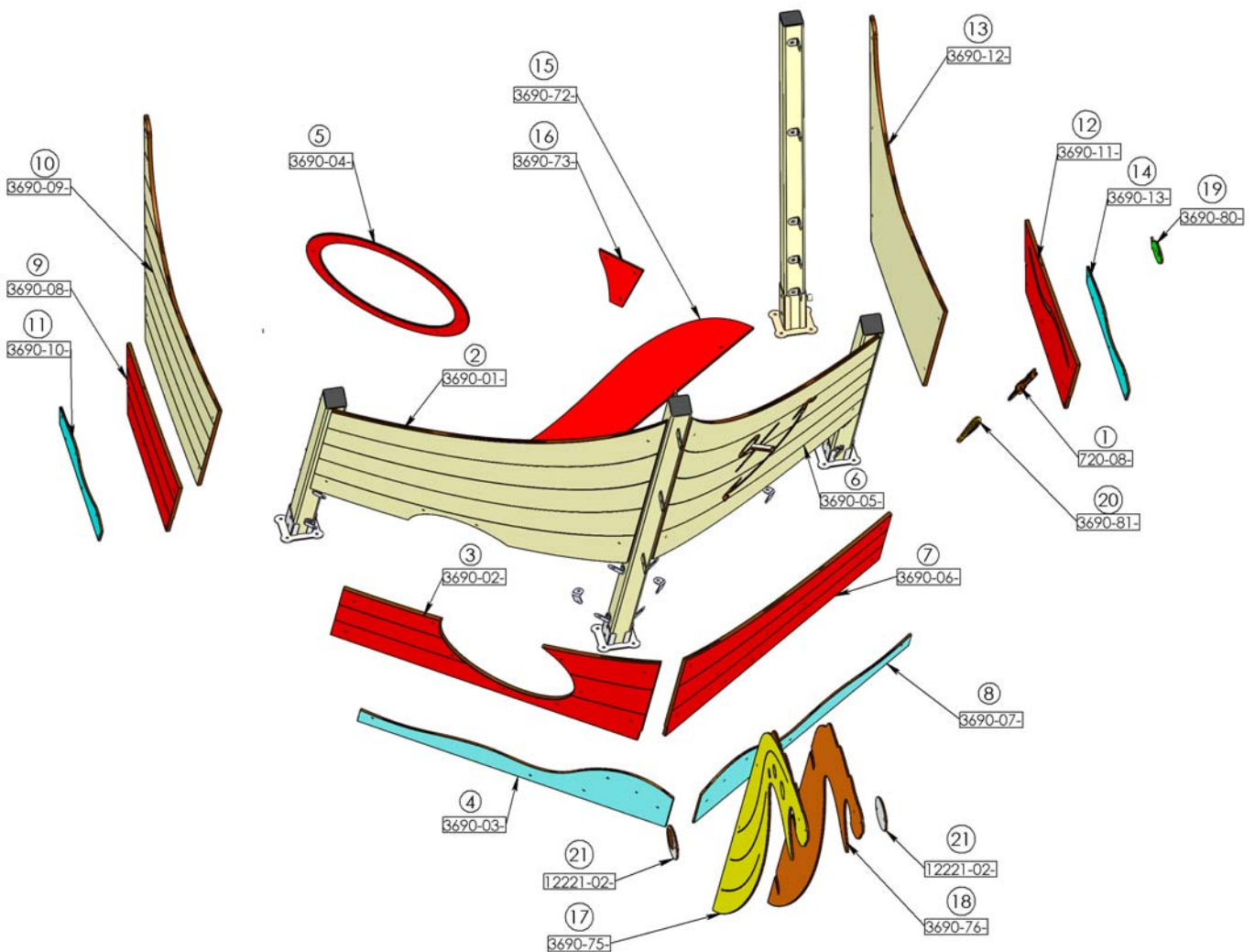



Réf. 3690 - Galion

Éclatée n°2

N°	REFERENCE	DESCRIPTION
1	3000-B-16	HPL
2	3000-F	HPL
3	3690-14	HPL
4	3690-15	HPL
5	3690-16	HPL
6	3690-17	HPL
7	3690-18	HPL
8	3690-19	HPL
9	3690-20 +810-25	HPL + plastique
10	3690-21	HPL
11	3690-22	HPL
12	3690-23	HPL
13	3690-24	HPL
14	3690-70	HPL
15	3690-78	HPL
16	3690-A	HPL
17	3690-E	HPL + inox
18	3690-F1	Corde armée diam.16
19	3690-F2	Corde armée diam.16
20	3690-F3	HPL
21	96940	HPL + inox

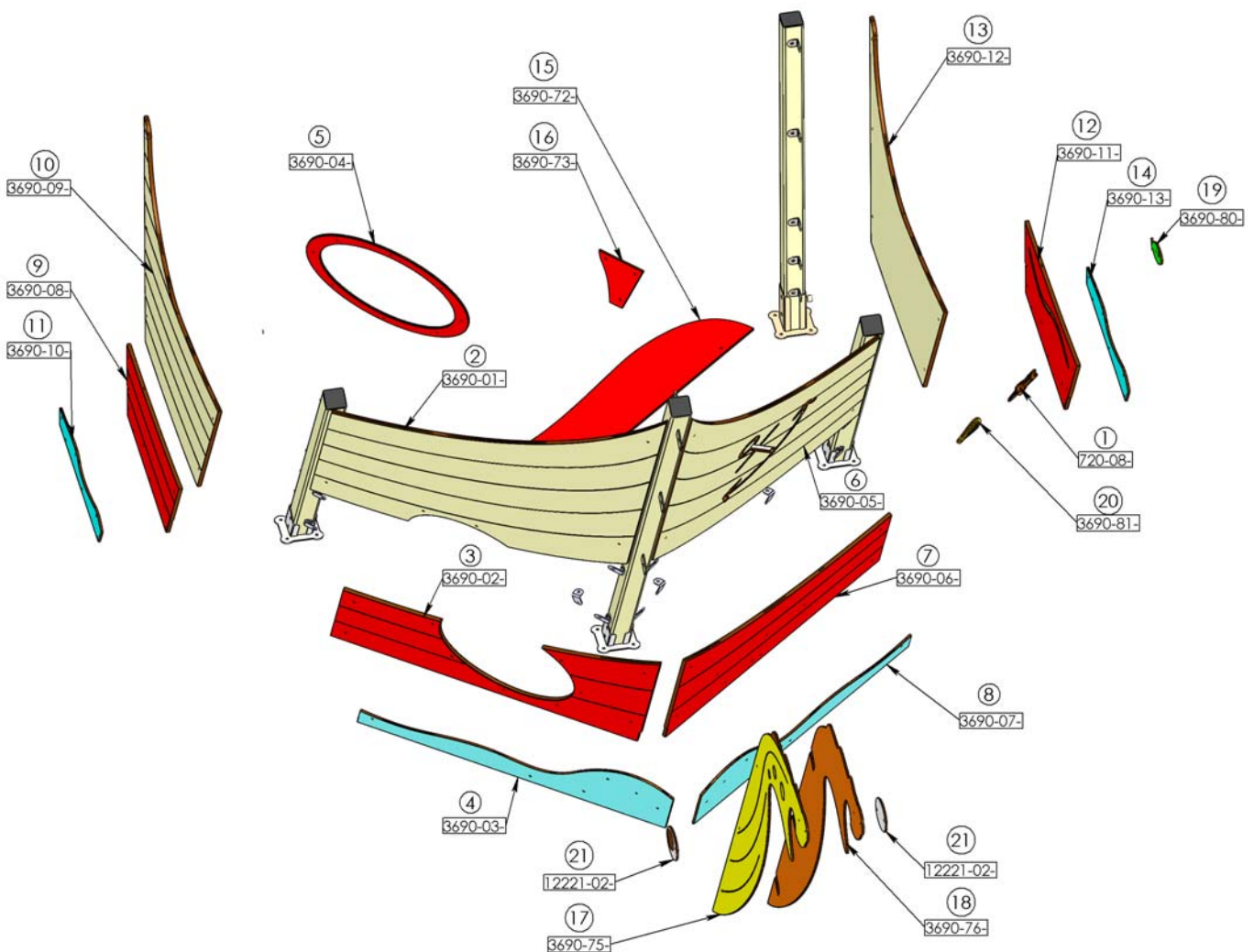

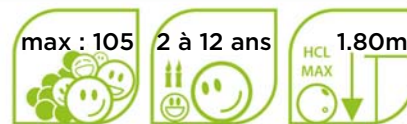

Réf. 3690 - Galion

Éclatée n°3

N°	REFERENCE	DESCRIPTION
1	3000-B-16	HPL
2	3690-14	HPL
3	3690-16	HPL
4	3690-17	HPL
5	3690-20 + 810-25	HPL + plastique
6	3690-25	HPL
7	3690-26	HPL
8	3690-27	HPL
9	3690-28	HPL
10	3690-29	HPL
11	3690-30	HPL
12	3690-32	HPL
13	3690-33	HPL
14	3690-34	HPL
15	3690-59	HPL
16	3690-60	HPL
17	3690-61	HPL
18	3690-70	HPL
19	3690-78	HPL
20	3690-79-1 à 6	HPL
21	3690-C	HPL + plastique
22	3690-F2	Corde armée diam.16
23	3690-F4	Corde armée diam.16
24	3690-GP	HPL + inox
25	96540	HPL + inox

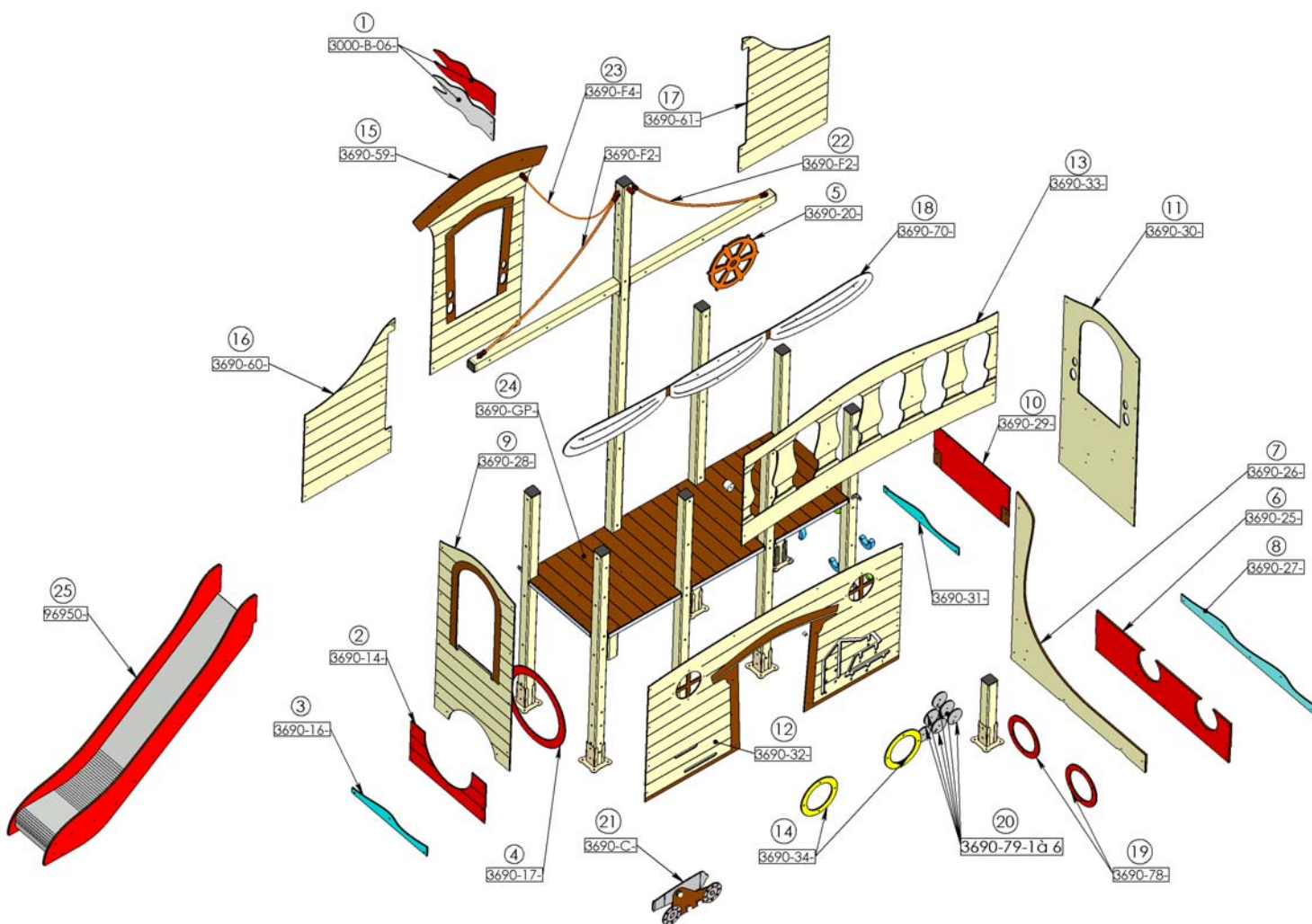

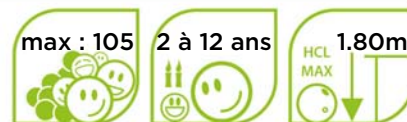

Réf. 3690 - Galion

Éclatée n°4

N°	REFERENCE	DESCRIPTION
1	3690-41	HPL
2	3690-42	HPL
3	3690-43	HPL
4	3690-44	HPL
5	3690-45	HPL
6	3690-46	HPL
7	3690-47	HPL
8	3690-48	HPL
9	3690-49	HPL
10	3690-50	HPL
11	3690-51	HPL
12	3690-52	HPL
13	3690-53	HPL
14	3690-54	HPL
15	3690-55	HPL
16	3690-56	HPL
17	3690-57	HPL
18	3690-58	HPL
19	3690-62	HPL
20	3690-63	HPL
21	3690-74	HPL
22	3690-77	HPL
23	3690-F-01	Corde armée diam.16
24	3690-T-01	HPL
25	3690-T-02	HPL

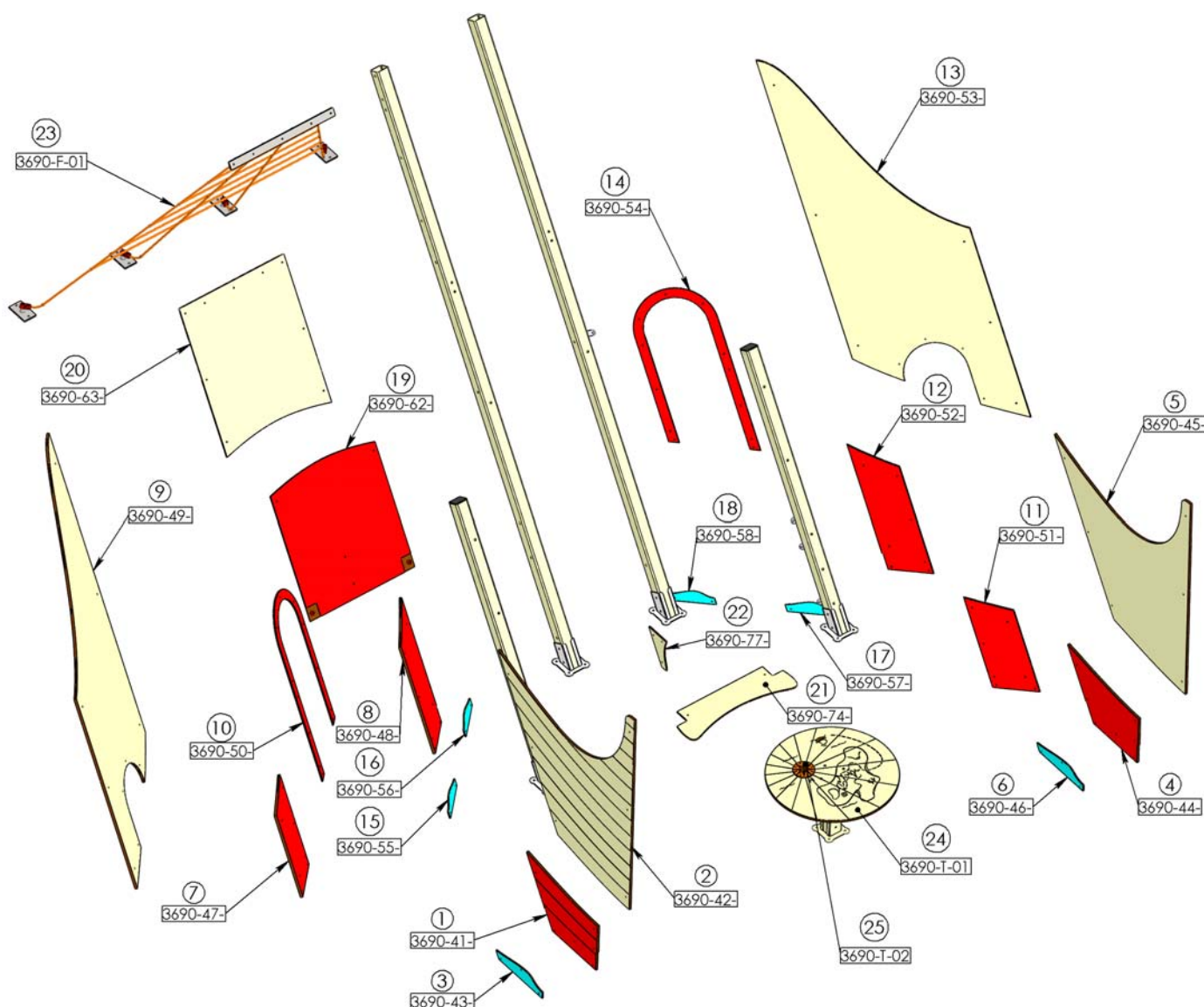



Réf. 3690 - Galion

Éclatée n°5

N°	REFERENCE	DESCRIPTION
1	3690-P-01	HPL
2	3690-P-02	Polycarbonate
3	3690-P-04	HPL
4	3690-P-05	HPL
5	3690-36	HPL
6	3690-36	HPL
7	3690-37	Polycarbonate
8	3690-38	HPL
9	3690-39	HPL
10	3690-40	Polycarbonate
11	3690-64	HPL
12	3690-66	HPL
13	3690-67	HPL
14	3690-68	HPL
15	3690-69	Polycarbonate
16	3690-71	HPL

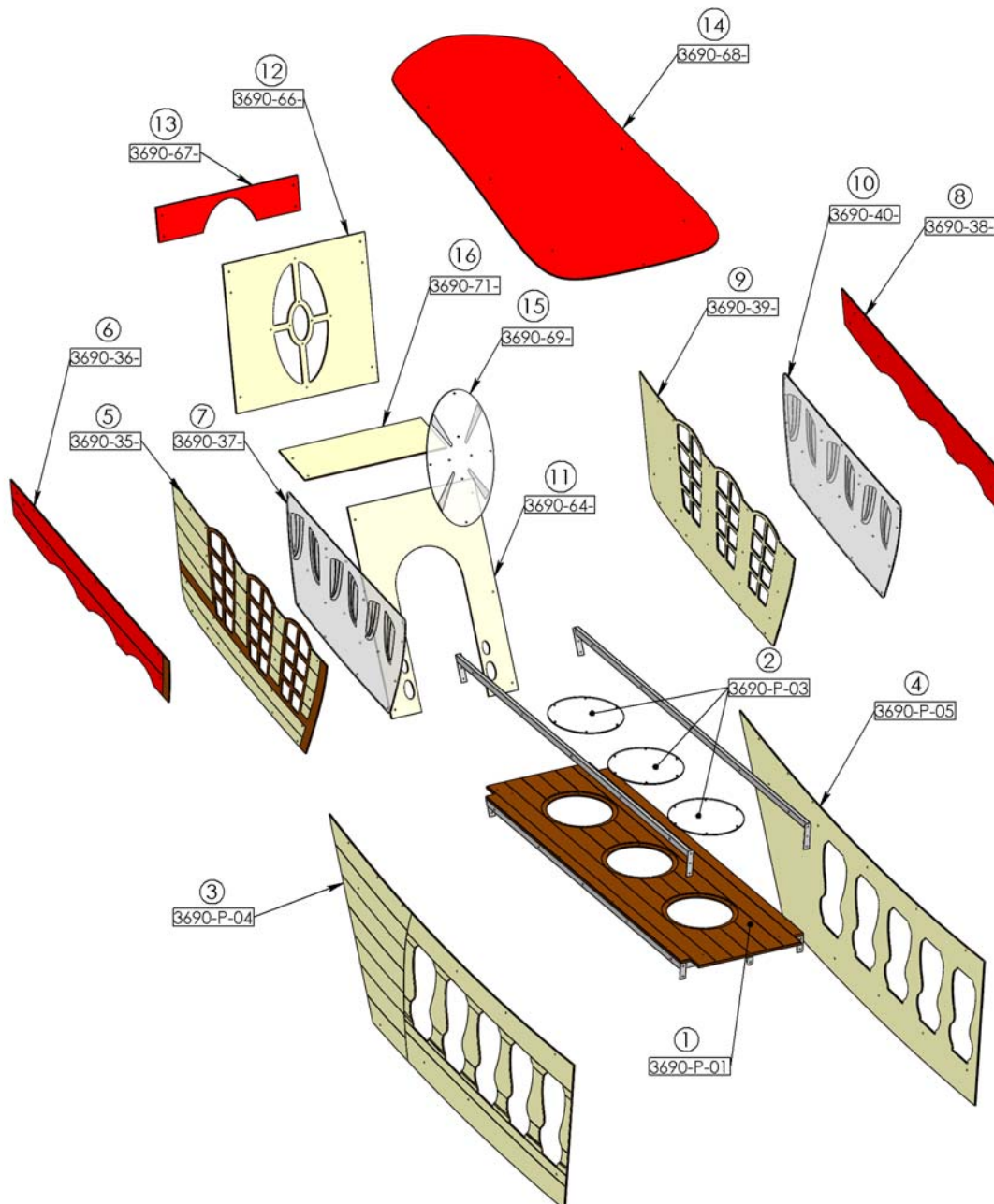

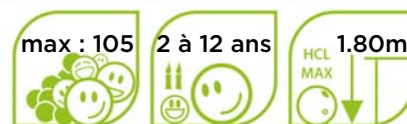

Réf. 3690 - Galion

Livraison, pose et montage

Poids de la pièce la plus lourde	45 Kg	Installation : Nbr jour / H	1 semaine / 3 personnes
Poids total	1600 Kg	m3 de béton	8.5 m3 (dalle béton)
Palettisation	3 palettes / 1x5/3x2/2.5x3	Réf. Notice	N3690

Scellements possibles

1

Sur sol fluent
(Copeaux - gravier roulés...)
-700 mm

2

Sur sol enrobé
-300 mm

3

Sur dalle béton
(Structure chevillée sur platine)

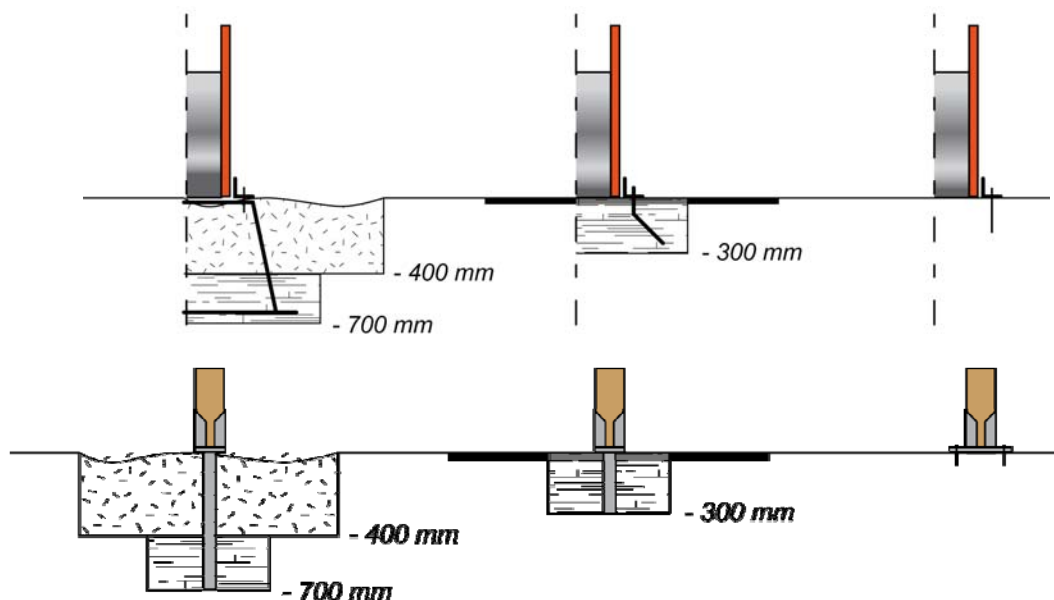

Contrôle, entretien, et maintenance

Transalp préconise d'effectuer :

- Un contrôle visuel hebdomadaire (effectué par la mairie)

Ce contrôle comprend la vérification de :

- l'intégrité du jeu
- respect des zones de sécurité (pas d'obstacle)
- la stabilité du jeu et de chaque agrès (monter sur le jeu et solliciter chaque agrès)

- Un contrôle fonctionnel et annuel (effectué par un organisme certifié)

Conforme
NF EN 1176-1177