

## Fiche technico-ludique

nov. 2019

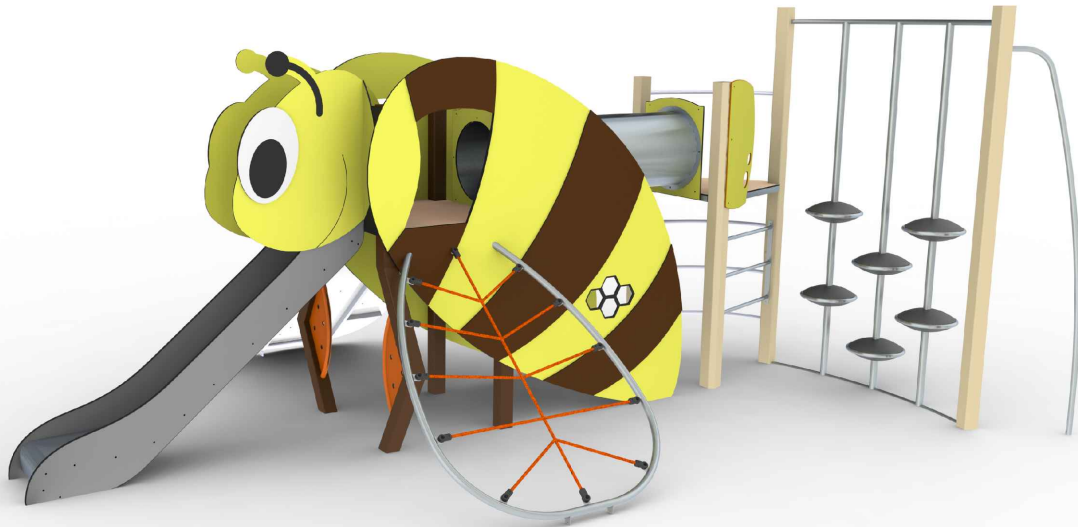

## réf. ST-19-002 - L'Abeille tunnel



**Vue élévation et plan de masse**

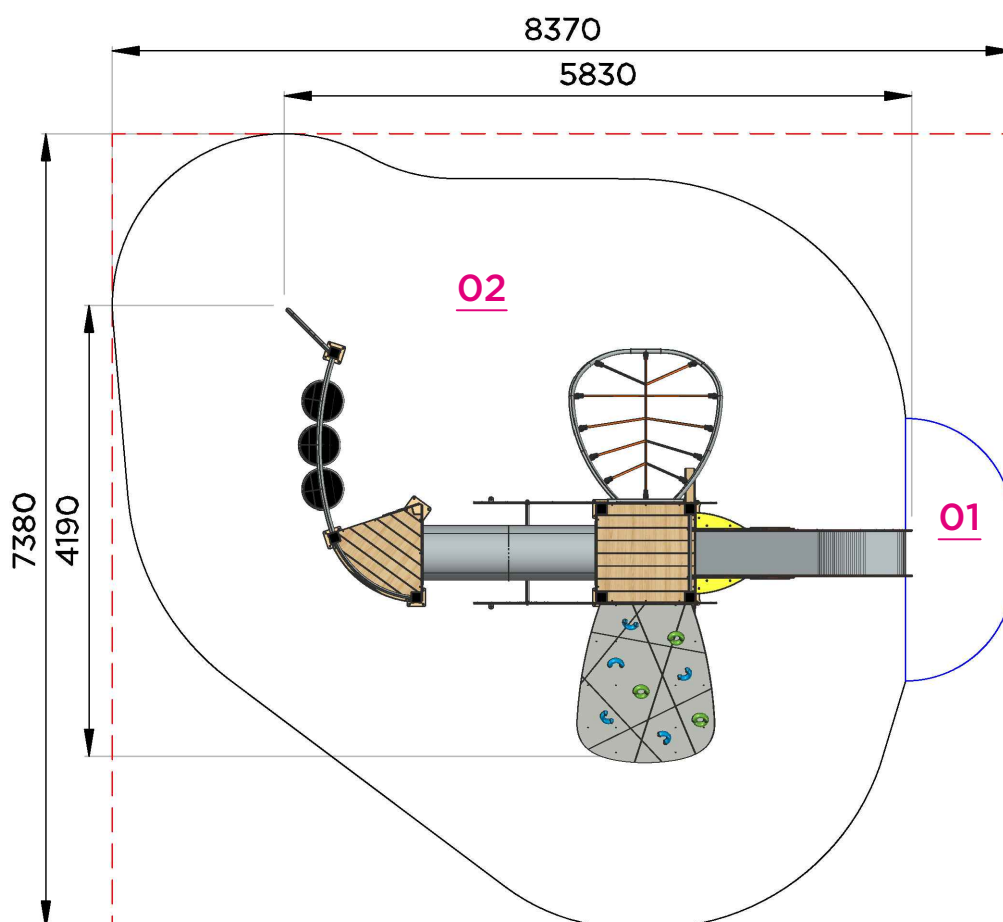
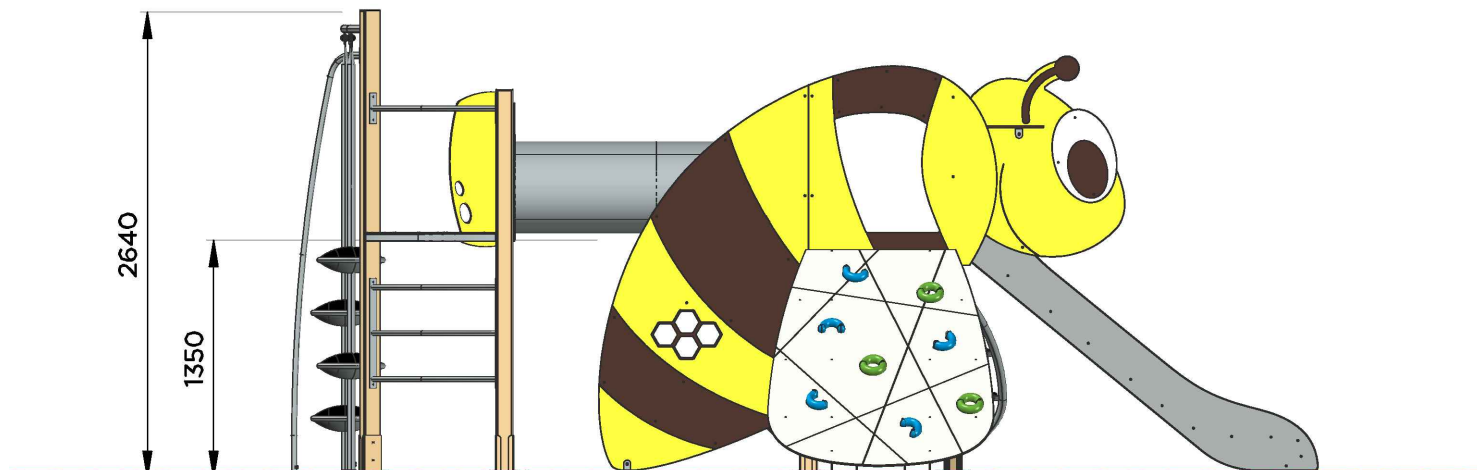

**Surfaces amortissantes nécessaires**

Ces surfaces sont calculées en fonction de la hauteur de chute libre (HCL)

**Surfaces totale HCL : 44.65 m<sup>2</sup>**

**01 : 1.00 m = 2.50 m<sup>2</sup>**  
**02 : 1.35 m = 42.15 m<sup>2</sup>**

Fiche technico-ludique

réf. **ST-19-002** - L'Abeille tunnel

## Fonctions ludiques

x 11

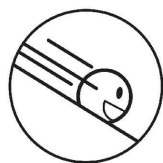

**GLISSER**  
Toboggan 1.35  
96950

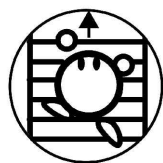

**GRIMPER**  
Filet 1.35  
4000-C

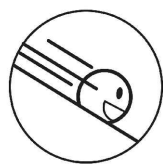

**GLISSER**



**S'ÉQUILIBRER**

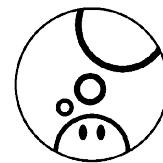

**IMAGINER**

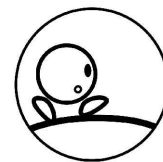

**TRAVERSER**

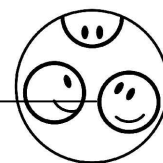

X2

**SE RENCONTRER**  
Plancher simple  
3000-F



**PASSER AU TRAVERS**

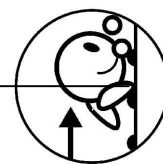

**ESCALADER**  
Mur d'escalade incliné 1.35  
3000-T



**MONTER**



**OBSERVER**

X2

## Matériaux

**ALUMINIUM** : poteaux 95 mm

**HPL (stratifié compact ép.13 mm et 10 mm)** : panneaux d'habillage / planchers / flans de toboggan / toiture

**INOX** : chassis / garde-corps / main courante / toboggan / mât pompier

## Livraison, pose, montage

Réf. Notice	<b>N3792</b>
Installation : Nbr jour / H	<b>8 heures / 2 personnes</b>
m <sup>3</sup> de béton	<b>0.357 m<sup>3</sup></b>

Palettisation	<b>1 palette / 3,50 x 1,50 m</b> <b>1 palette / 2,60 x 0.80 m</b> <b>1 palette / 2,50 x 0.80 m</b>
---------------	--

Poids de la pièce la plus lourde	<b>60 Kg</b>	Poids total	<b>450 Kg</b>
----------------------------------	--------------	-------------	---------------

## Scellements possibles

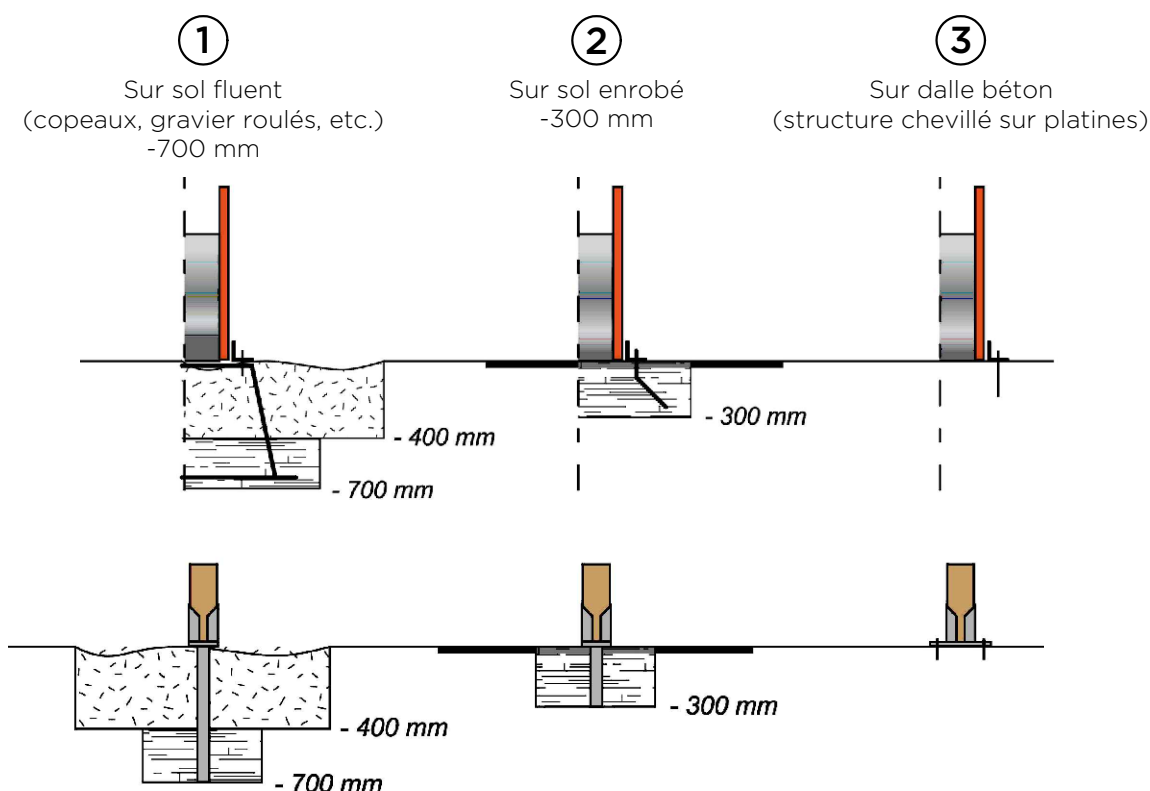

## Contrôle, entretien et maintenance

TRANSALP préconise d'effectuer :

**- un contrôle visuel hebdomadaire (effectué par la mairie)**

Ce contrôle comprend :

- l'intégrité du jeu
- le respect des zones de sécurité (pas d'obstacle)
- la stabilité du jeu et de chaque agrès (monter sur le jeu et solliciter chaque agrès)

**- un contrôle fonctionnel et annuel (effectué par un organisme certifié)**

